

KLT-G1M9WF3+KLT-CMFL60101-IMX335 V1.0

Ai Master Board + WiFi Board + 5.14MP Sony IMX335 Fixed Focus Camera Module Development Kit

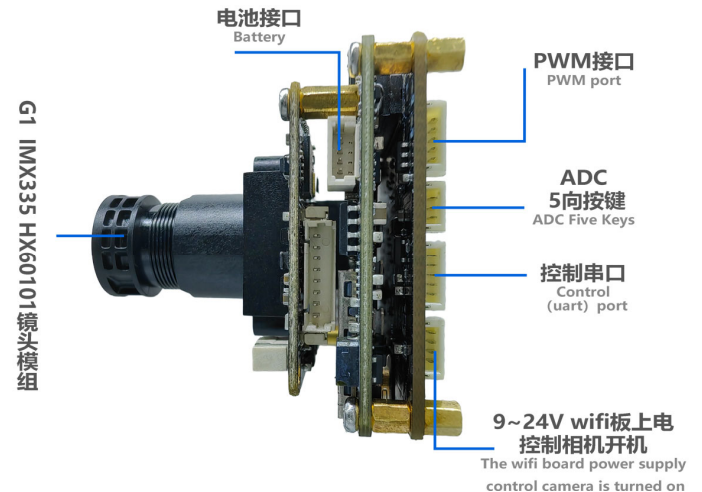

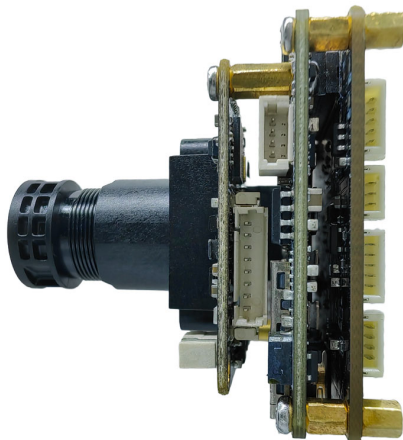
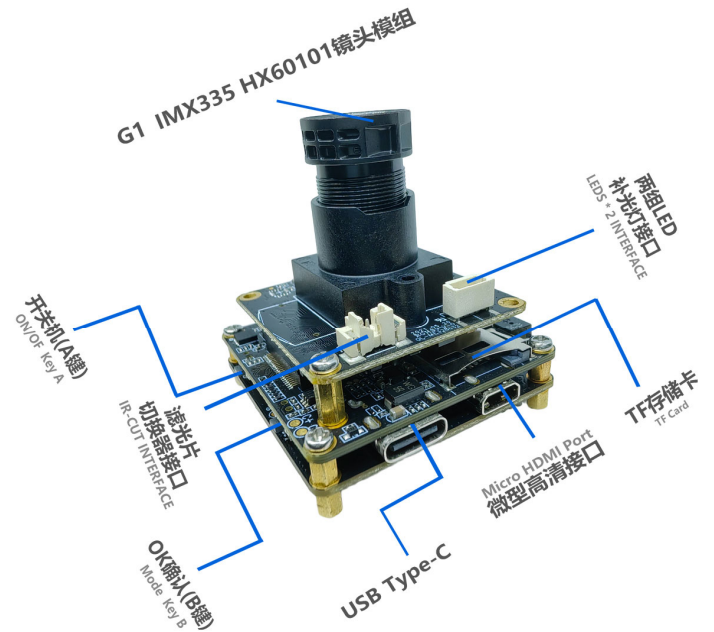

KLT-G1M9WF3+KLT-CMFL60101-IMX335 V1.0

Ai Master Board + WiFi Board + 5.14MP Sony IMX335 Fixed Focus Camera Module Development Kit

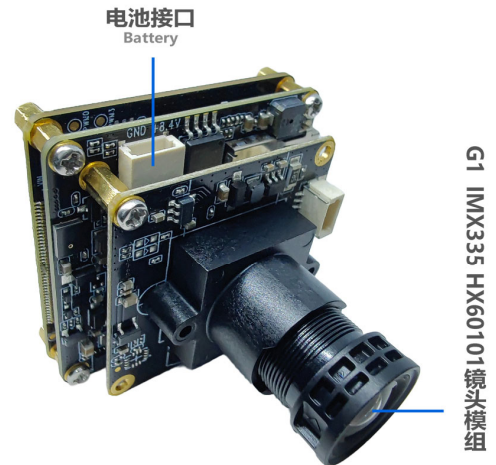
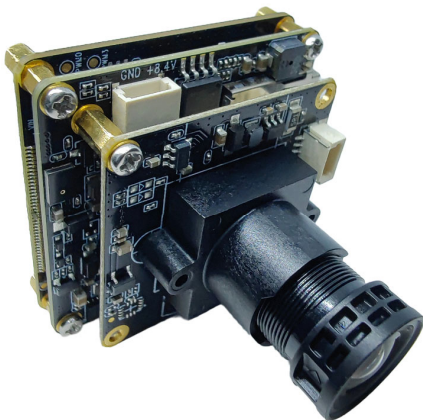
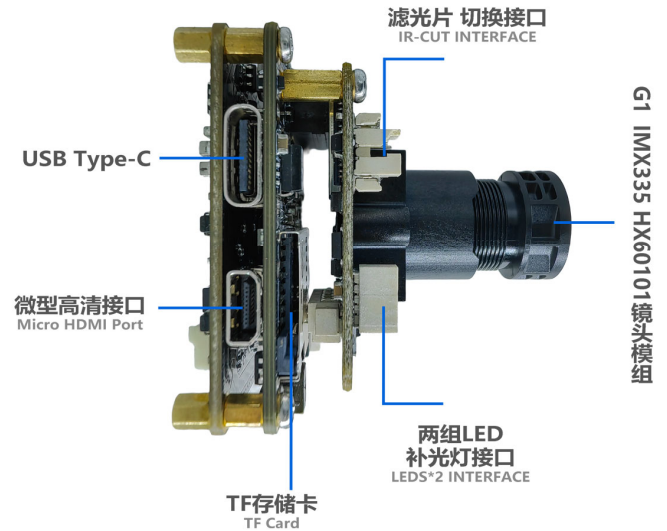
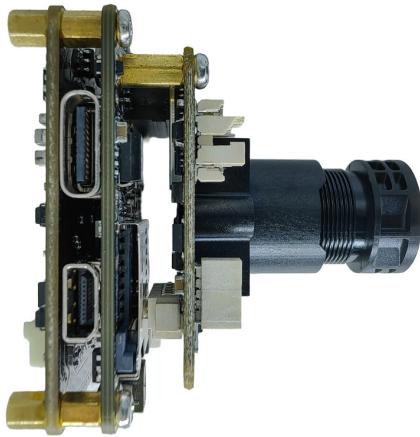



KLT-G1M9WF3+KLT-CMFL60101-IMX335 V1.0

Ai Master Board + WiFi Board + 5.14MP Sony IMX335 Fixed Focus Camera Module Development Kit

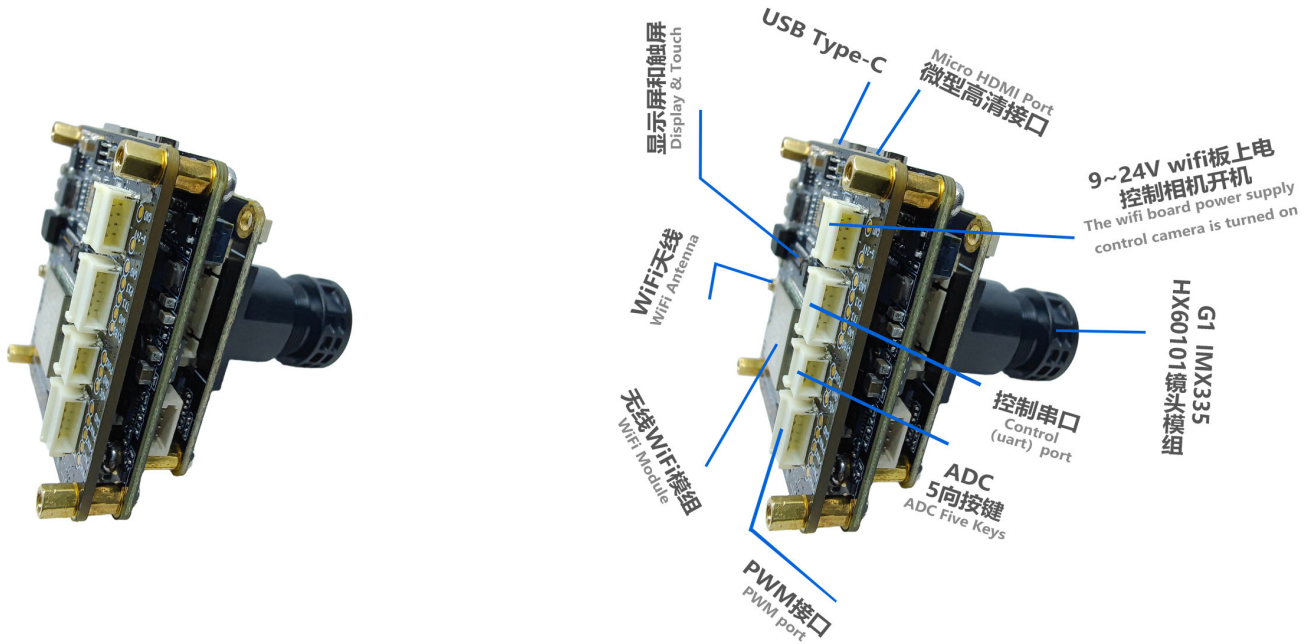

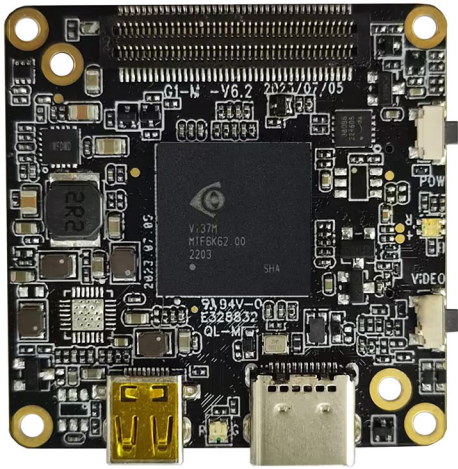
KLT-G1M9 V6.2**iCatch V39 Ai-Powered Image Processing SoC Master Board**

Front View

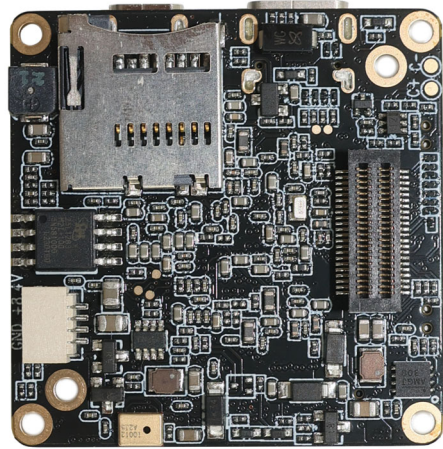

Back View

Overview

Equipped with iCatch V39, built-in 2GB DDR3, supports up to 4K@60FPS (differential), 4K@30FPS, 1080P@120FPS H.264 encoded video. Onboard support Type-C, HDMI, TF memory card, recording, 2 control buttons, buzzer, battery power supply, etc.

This master board extension also supports WiFi, LCD display, CVBS, lens module, UART, I2C, SPI, PWM, MIC and other expansion interfaces. The board size is 38x38mm. Widely used in drones, mini DV, wearable devices, sports cameras, face recognition, USB cameras and other camera products.

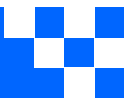

KLT-G1M9 V6.2

iCatch V39 Ai-Powered Image Processing SoC Master Board

Hardware Specifications

Model No.	KLT-G1M9 V6.2
Main Control Chipset (DSP)	iCatch V39
Image Sensor Interface	MIPI
Battery Voltage	7.4V - 7.7V High Voltage Lithium Battery
Storage Type	External TF Card, Supports 8GB - 512GB Class 10 and Above, U3 is Recommended
Type-C Port	Type-C USB 5V Connection to Computer USB Mode Connection to PCCAM (Camera) Mode
LED Indicator Type	Three Color Light (Red, Green, Blue)
2 Control Button Type	Power Button (A), OK Button (B)
Power Supply	Supports 3 Power Supply Methods At The Same Time (1) 5V USB to Type-C Port Power Supply (2) 9V-24V WiFi Board or Network Port board Power Supply (3) 6.8V-8.4V Battery Power Supply (The 3-Axis Gimbal Version Does Not Support 5V USB)
Operating Temperature	-10°C to +60°C Without Housing
Storage Temperature	-20°C to +80°C
Humidity	20% to 80%
PCB Dimensions	38 x 38 mm
PCB Screw Hole Spacing	External (34mm x4), Internal (28mm x2)
PCB Screw Hole Diameter	2 mm
Optional Camera Configuration	(1) KLT-G1M9 V6.2 + Camera (2) KLT-G1M9 V6.2 + Camera + KLT-G1WF V6.3 WiFi Board (3) KLT-G1M9 V6.2 + Camera + KLT-G1NK V6.3 Ethernet Board
Supportive Image Sensors	13MP: IMX258 12MP: IMX377 OS21D40 IMX577 IMX386 IMX378 8MP: IM317 5MP: IMX335 2MP: IMX290 IMX385
Optional Extension Ports	WiFi, Ethernet Network Port, Display, Audio IC, Lens Module, UART, I2C, SPI, PWM, MIC, etc.



KLT-G1M9 V6.2

iCatch V39 Ai-Powered Image Processing SoC Master Board

Photo Image Settings

Resolution	20MP, 13MP, 12MP, 10MP, 8MP, 5MP, 3MP, 2MP
Time Lapse Photography	OFF, 3S, 5S, 7S
Continuous shooting	OFF, 3-Shot, 7-Shot, 15-Shot, 30-Shot
White Balance	Auto, Sunny, Cloudy, Fluorescent, Incandescent
Power Frequency	50Hz, 60Hz
Exposure Compensation	EV 0.0, EV 3.0, EV 7.0, EV 10.0, EV 13.0, EV 17.0, EV 20.0, EV -3.0, EV -7.0, EV -10.0, EV -13.0, EV -17.0, EV -20.0
Time Lapse Photo Interval	OFF, 1S, 2S, 3S, 4S, 5S, 6S, 7S, 8S, 10S, 13S, 15S, 20S, 25S, 30S, 40S, 1min
Time Lapse Duration	No Limit, 1min, 3min, 5min, 10min, 20min, 30min, 1hr, 2hr, 3hr, 5hr
Photo Time Watermark	OFF, Date, Date and Time

Wifi、显示屏、网口、uart、PWM等扩展接口

For Wifi, Display, Network, uart, PWM Etc.

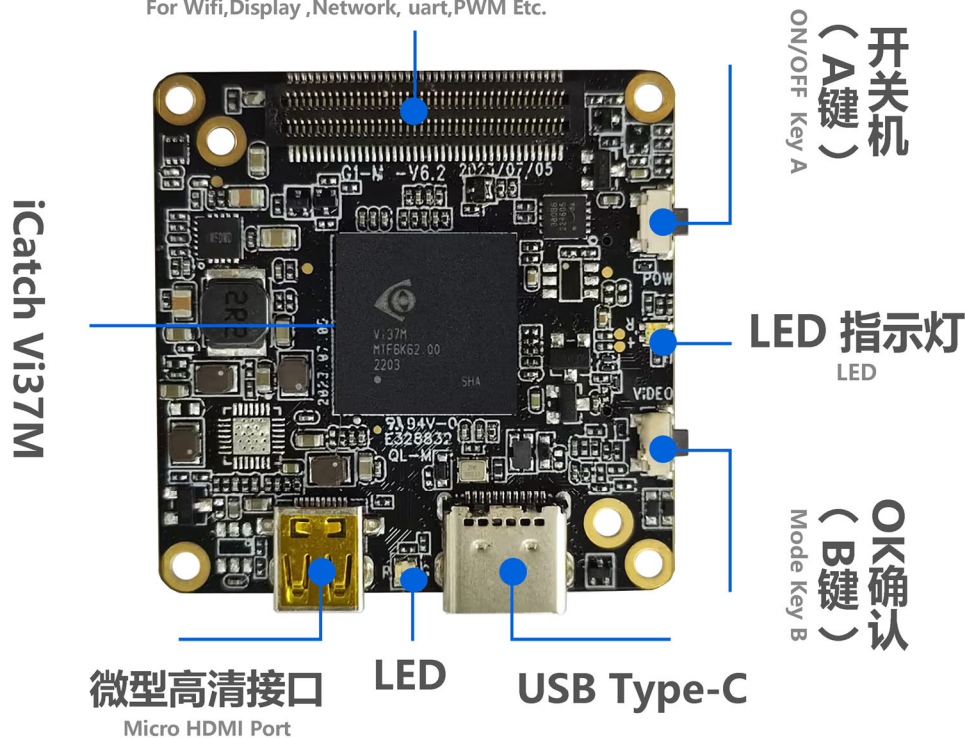



KLT-G1M9 V6.2

iCatch V39 Ai-Powered Image Processing SoC Master Board

Video Settings

Resolution	16:9 (4K, 2.7K, 1080P, 720P) 4:3 (1440P) Currently Only IMX377 Sensor Supports 1440P
Frame Rate	24FPS, 25FPS, 30FPS, 48FPS, 50FPS, 60FPS, 120FPS, 240FPS
Slow Motion Recording	OFF, 4K2X, 1080P4X, 720P8X
Fast Motion Recording	OFF, 2X, 5X, 10X, 15X, 30X
Automatic Recording	OFF, ON
Time Lapse Video Mode	OFF, 1S, 2S, 3S, 4S, 5S, 6S, 7S, 8S, 10S, 13S, 15S, 20S, 25S, 30S, 40S, 60S
Time Lapse Duration	No Limit, 1min, 3min, 5min, 10min, 20min, 30min, 1hr, 2hr, 3hr, 5hr
Pre-recording	OFF, ON (for Option ON, 5 Seconds of Video is Pre-recorded)
EIS Anti-Shake	OFF, ON
Image Quality Enhancement	Super Good, Very Good, Normal (Referral to Actual Video Effect Quality, Not for Preview)
Image Rotation	Normal, Vertical, Horizontal (for Recorded Video)
Recording Time	No Limit, 1min, 5min
Automatic Screen Off	OFF, 60S, 180S, 300S
Light Metering Mode	Center, Multi-point, Single Point
Video Recording File Time	No Limit, 1min, 5min
Loop Recording	OFF, ON
Recording Volume	0, 1, 2, 3
Video Time Watermark	OFF, Date, Date and Time

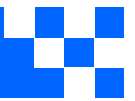

KLT-G1M9 V6.2

iCatch V39 Ai-Powered Image Processing SoC Master Board

System Settings

Automatic Shut Down	OFF, 1min, 3min, 5min, 10min, 15min
USB Auto Power On	Turn ON, Turn OFF
Languages	English, Simplified Chinese, Traditional Chinese (Select Language Through Configuration File in the Card)
Button Touch Tone	Turn ON, Turn OFF
Automatically Turn On WiFi	Turn ON, Turn OFF
WiFi Frequency Bands	2.4GHz or 5GHz (Dual Band Single Channel)
Display Brightness	Low, Medium, High Brightness (for Touch Screen)
Display Setting	Conventional Display, Full Screen Display (for Touch Screen)
Fill Light A (White Light)	Auto, OFF, ON (for Use with Fill Light Board)
Fill Light B (Infrared Light)	Auto, OFF, ON (for Use with Fill Light Board)
IR Cut Settings	Auto, OFF, ON (for Use with IR Cut Function Modules)
Special Effects	Original Image, Black and White, Natural, Negative, Warm Tones, Contrast (for Touch Screen)
White Balance	Auto, Sunny, Cloudy, Fluorescent, Incandescent
Date and Time	Year, Month, Day, Hour, Minute
Format	No, Yes
Reset	No, Yes
Card Information	Displays Video Card Capacity and Free Space
Device Information	Displays Firmware Version

Gimbal Functions and Settings

Gimbal Functions	Centering, Calibration
Sensitivity	Follow Softly, Follow Sensitively
Follow Mode	Full Follow, Heading Follow, Heading and Pitch Follow
Pitch Axis Control	Turn ON, Turn OFF

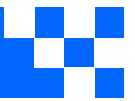

KLT-G1M9 V6.2

iCatch V39 Ai-Powered Image Processing SoC Master Board

Camera Features

Continuous Shooting	Long Press the OK Button (B) to Shoot Continuously, Release Button to Stop Shooting Continuously
Snapshot	During Recording, Long Press the OK Button (B) to Capture the Video. Release Button to Stop Snapshot
HDMI Output Resolution	4K@30FPS 1080P@60FPS/30FPS 720P@60FPS
Video Start and Stop Function	Short Press the Power Button (A) to Pause or Continue Video Recording
USB Camera Resolution	H.264: 4K@30FPS, 1080P@120FPS, 720P@60FPS (Dependency on Sensor Type and UVC Protocol) MJPG: 5760x3240@10FPS, 4000x3000@10FPS 4K@30FPS, 1080P@30FPS, 720P@30FPS YUY2: 480P@30FPS (Supports Modification of UVC Output on Configurations)
USB Flash Drive	USB Mode when Connected to Computer
Inverted Mode	By Placing a Configuration File in the Card, You Can Modify the Displayed or Captured file and Flip it 180 degrees
WiFi Mode	AP Mode, STA Mode Set WiFi Mode by Putting Configuration Files in the Card or Enter the Menu to Set This Item Through the Touch Screen
Configuration IP Address	By Placing a Configuration File in the Card, You Can Modify the IP and Gateway Address of the Camera. Default is Static IP. Optional on Dynamic IP.
RTSP Video Stream Address	By Placing a Configuration File in the Card, You Can Modify the RTSP video stream address. If There is No Configuration File in the Card, the Default Port is 554.

KLT-G1M9 V6.2**iCatch V39 Ai-Powered Image Processing SoC Master Board****USB Type-C Interface:**

This interface supports USB standard 5V power input, which can power the master board and charge the battery (recommended 7.4V-7.7V battery). Connecting to a computer can directly read files in the TF card and use it as a USB flash drive. It can also be used as a PCCAM USB camera.

The USB interface retains one camera control serial port UART3 and one camera debugging serial port UART1 (the serial port function can be used with the G1-USB serial port debugging board).

Connecting to the Computer USB Flash Drive Mode:

Insert the TF card, connect the other end of the USB to the computer, and automatically enter the USB flash drive mode after booting by default.

Connecting to the Computer PCCAM Mode:

Insert the TF card, connect the other end of the USB to the computer, and automatically enter the USB flash drive mode after booting. Short press the OK button (A) to switch to PCCAM camera mode. (Right-click the computer "Computer", click the left button in the pop-up prompt box to enter "Management", "Device Manager", and you can see the name of the camera identified in "Image Device" camera. Open the camera tool "amcap.exe" to see the current device preview screen).

Battery Power Supply:

6.6V (low power shutdown) to 8.8V, 7.4-7.7V high-voltage and high-density batteries are recommended
Special note: the battery power supply can support up to 12V; but this does not include the gimbal version, the stable power supply voltage of the gimbal version is 8V.

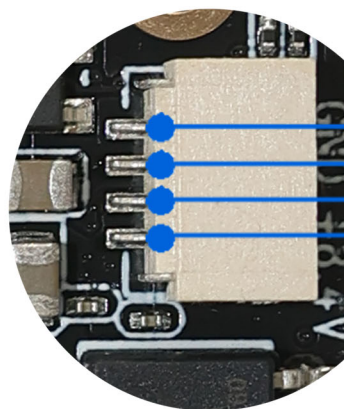
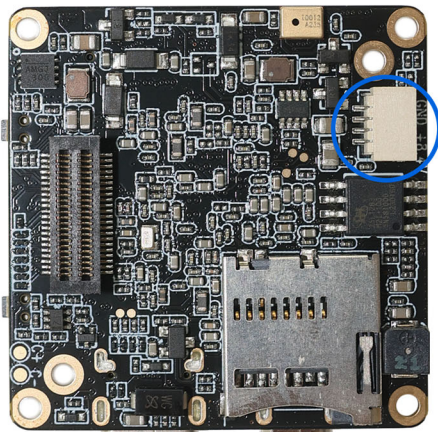

BAT -
BAT +

Battery 7.7V-8.8V
电池供电

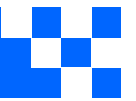
**KLT-G1M9 V6.2****iCatch V39 Ai-Powered Image Processing SoC Master Board****Charge the Battery:**

Use a power adapter (5V2A recommended) to charge the battery of the machine. The red light will be on during charging and the green light will be on when fully charged.

Camera Module:

This interface can be used to expand multiple MIPI sensors, IR-CUT function, LED fill light, serial port UART2, battery power output, micro three-axis gimbal and other functions.

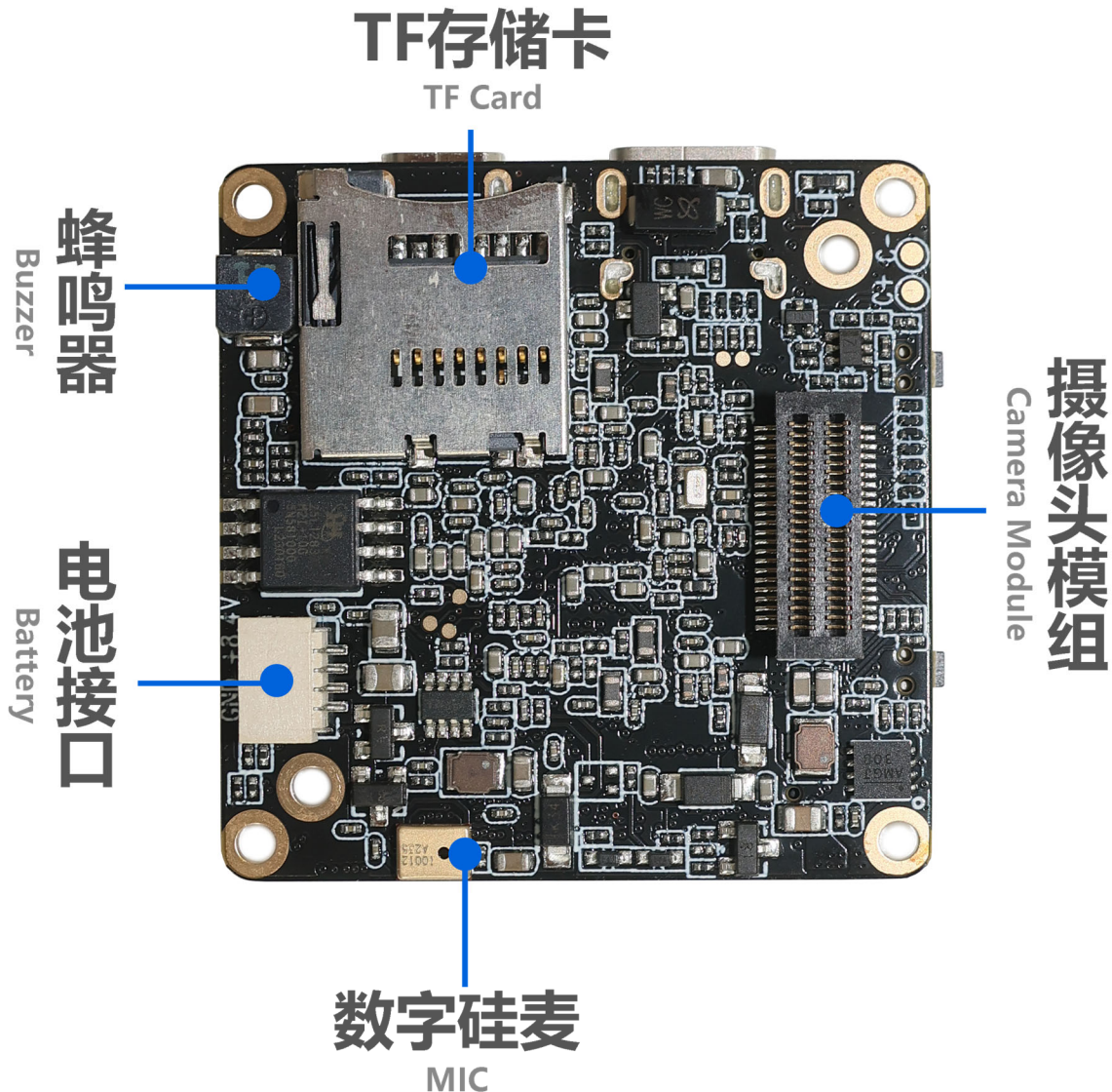

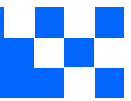

KLT-G1M9 V6.2

iCatch V39 Ai-Powered Image Processing SoC Master Board

Button Instructions:

Button	Mode or Status	Functional Operation
Button A Power Mode	Power ON / OFF	Long Press 1 Second Power ON / OFF
	Standby	Short Press on Switch Mode Video Recording, Snapshot, Playback, Settings
	Setting Mode (with Touch Screen)	Short Press to Scroll Down Menu (After Pressing Button B to Enter Setting)
	Video Recording	Short Press to Pause or Continue Recording
Button B Confirmation OK Video Recording	Standby	In Video Standby Mode, Long Press 3 Seconds to Turn ON / OFF WiFi Mode. Default WiFi is OFF. In Video Recording Mode, Short Press to Start Recording In Snapshot Mode, Short Press to Start Taking Photo Long Press to Start Continue Shooting Release to Stop Continue Shooting
	Video Recording	Short Press to Stop Recording and Save the File Long Press 2 Seconds (Less than 4 Seconds) to Take a Single Frame Shot, Release to Stop Taking Frame Shots Long Press 5 Seconds to Take Continues Frame Shots, Release to Stop Taking Frame Shots
	Setting Mode (with Touch Screen)	Short Press to Confirm and Enter Setting Mode Long Press 2 Seconds to Return Double-Click to Switch Between Settings: Photo / Video / System / 3-Axis Gimbal
	Playback Mode (with Touch Screen)	Short Press to Scroll Up Menu Double-Click to Play / Pause Video or Audio Files Click 3 Times to Mark or Unmark Files. If File is Marked, then the File is Locked and Not Erasable Long Press to Prompt Option to Delete Current File (Long Press to Delete, Short Press to Return) After Entering, Long Press Again to Delete
	Shutdown	Press and Hold to Enter the USB Burning Mode
Reset Function	Standby or Working	Press Button A and B at the Same Time to Shutdown

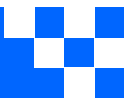

KLT-G1M9 V6.2

iCatch V39 Ai-Powered Image Processing SoC Master Board

LED Indicator Description:

Functions	Color	Power On	Video Mode	Video Recording	Photo Mode	Photo Snapshot	Playback Mode	Setting Mode
LED Indicator	Red	Always On	Always On	Flashing			Always On	
	Green				Always On	Flash Once	Always On	
	Blue						Always On	Always On

Note: When the device is powered without a TF card inserted, the function indicator light flashes yellow.

Buzzer Sound Description:

Operation Mode	Power On	Power Off	Switching Mode	Start Video Recording	Start Stop Recording	Photo Snapshot	Menu Setting	Menu Scroll Down	Exit Menu Setting
Buzzer Sound	3 Beeps	5 Beeps	1 Beep	1 Beep	2 Beeps	1 Beep	1 Beep	1 Beep	1 Beep

Special Note: When the touch screen is not in use, you can modify the setting parameters through the configuration file. Put the configuration file, such as "CameraConfig_G1A.ini" (the specific configuration file name will vary depending on the lens module) in the root directory of the TF card, and you can modify the corresponding function options in the configuration file. After saving the changes, shut down the machine and restart it to take effect.



KLT-G1WF V6.3 WiFi Expansion Board

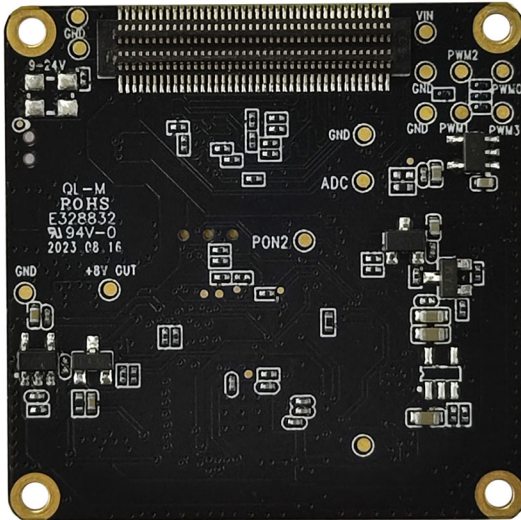

Front View

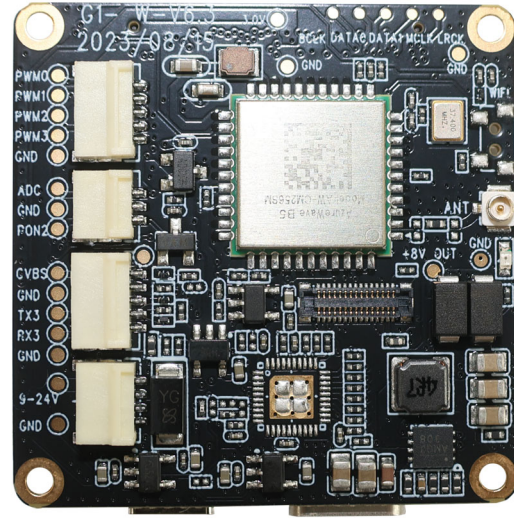

Back View

Overview

WiFi expansion board is equipped with the AW CM256SM single-pass dual-band WiFi module, which supports the use of single-band 2.4GHz or 5GHz wireless WiFi functions. The board supports WiFi antenna, reserved WiFi button (Button C), serial port (UART3), etc.

PWM, ADC button, touch screen and other expansion interfaces included. The board PCB size is 38x38mm, and it must be used with our company's designated master board. This WiFi board can not work independently.



KLT-G1WF V6.3 WiFi Expansion Board

Specifications

Model No.	KLT-G1WF V6.3
WiFi Module	AW CM256SM
Power Supply	Supports 3 Power Supply Methods At The Same Time (1) 5V USB to Type-C Port Power Supply (2) 9V-24V WiFi Board Power Supply (3) 6.8V-8.4V Battery Power Supply (The 3-Axis Gimbal Version Does Not Support 5V USB)
WiFi Frequency Bands	2.4GHz or 5GHz (Dual Band Single Channel)
Wireless Network Standards	IEEE 802.11B/G/N/AC, WiFi Compliant
2.4GHz Frequency Range	2.400GHz - 2.472GHz (2.4GHz ISM Band)
2.4GHz Channels	2.4GHz: Channel 1 - Channel 13
2.4GHz Transmission Rate	2 - 3 Megabytes
2.4GHz Transmission Distance	50 Meters (No Disruption)
5GHz Frequency Range	5.150GHz - 5.825GHz (5GHz ISM Band)
5GHz Channels	5GHz: Channel 1 - Channel 13
5GHz Transmission Rate	6 - 8 Megabytes
5GHz Transmission Distance	30 Meters (No Disruption)
CVBS (TV-Out)	720 x 576
CVBS Standards	NTSC / PAL (TV-Out)
Serial Port / UART	RX3, TX3, GND
ADC Button	Up, Down, Left, Right, OK 5-Way ADC Buttons Power Button
Operating Temperature	-10°C to +60°C Without Housing
Storage Temperature	-20°C to +80°C
Humidity	20% to 80%
PCB Dimensions	38 x 38 mm
PCB Screw Hole Spacing	34 mm
PCB Screw Hole Diameter	2 mm
Extendable Functions	PWM, ADC Buttons, WiFi Board Power Supply UART3 Serial Port, Touch Screen, Other Interfaces

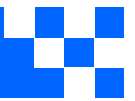

KLT-G1WF V6.3 WiFi Expansion Board

Hardware Interface Function Description

AW CM256SM single-pass dual-band WiFi module supports single-band 2.4GHz or 5GHz wireless WiFi function, and adopts the first generation IPEX universal copper standard antenna.

In the video mode standby state, long press the master board Button B, that is, long press the motherboard shooting button for 3S to turn on WiFi. The red light flashes when WiFi is turned on, and the red light is always on after the connection is successful.

PWM接口
PWM port

无线WiFi模组
WiFi Module

**ADC
5向按键**
ADC Five Keys

控制串口
Control
(uart) port

WiFi天线
WiFi Antenna

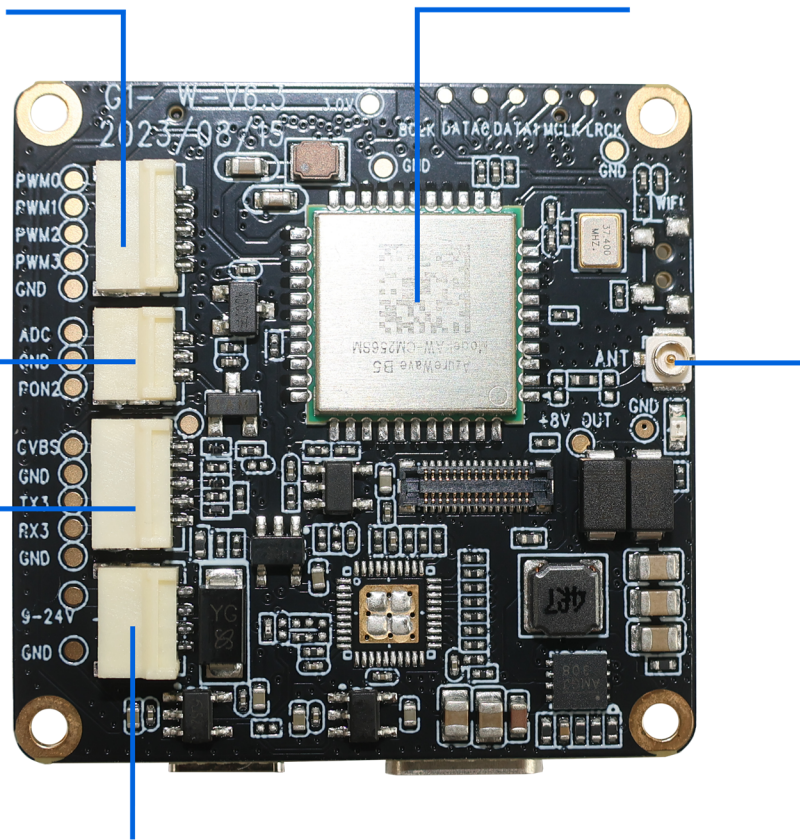

9~24Vwifi板上电控制相机开机

The wifi board power supply control camera is turned on

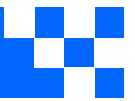

KLT-G1WF V6.3 WiFi Expansion Board

The PWM function interface, which can be used to control camera mode switching, photo taking, video recording and other functions.

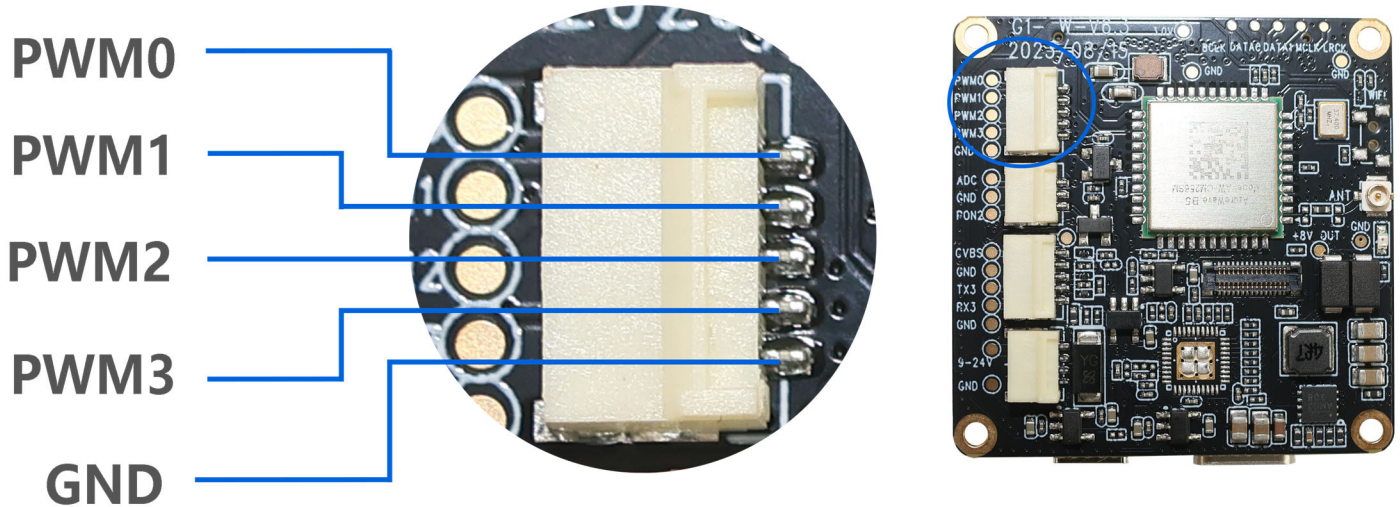

Supports one ADC button interface, which can be connected to five buttons: up, down, left, right, and OK, to control the camera's recording, taking pictures, turning on WiFi, etc. Supports external buttons to control the camera's power on and off.

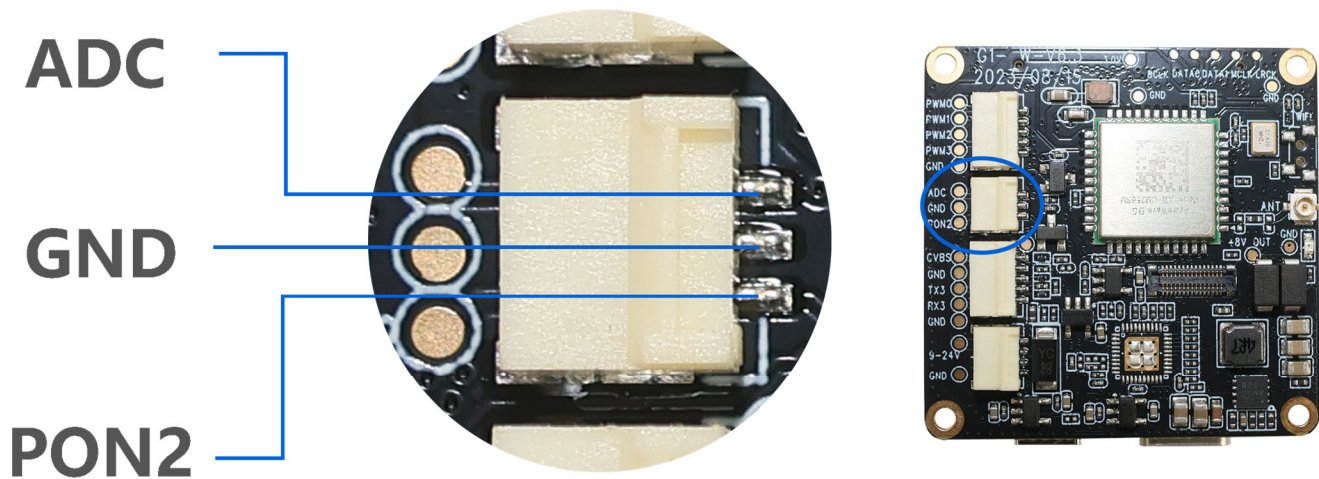



KLT-G1WF V6.3 WiFi Expansion Board

Supports one analog video CVBS (TV-OUT) signal output, with RX3 and TX3 reserved ports, and the camera can be set and controlled through this serial port.

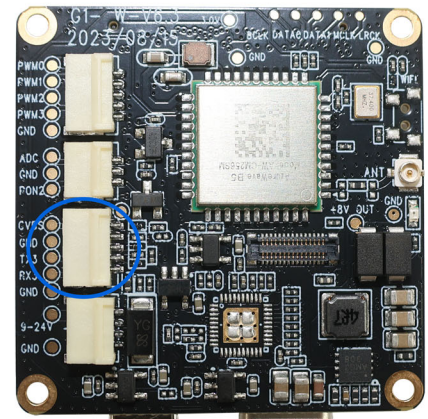
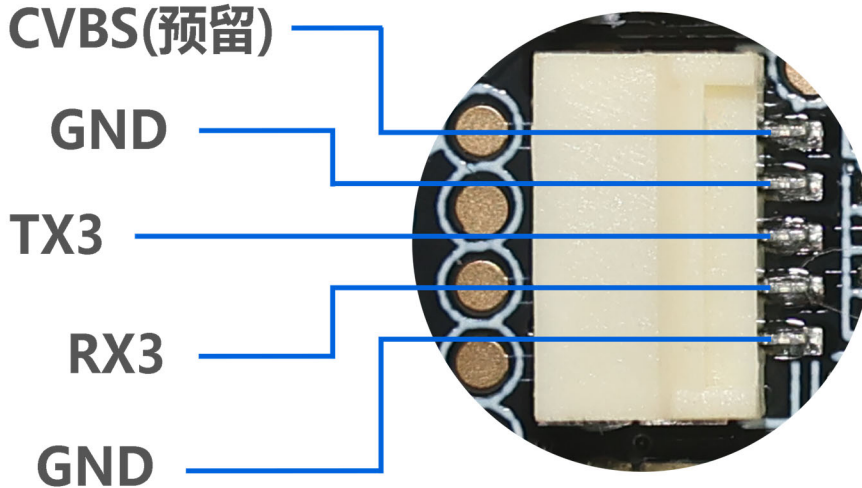

The camera can be powered on automatically using 9V-24V power supply; the master board supports three-way simultaneous use, namely WiFi board power supply, motherboard battery power supply, and Type-C USB power supply. It can also be used with a single power supply.

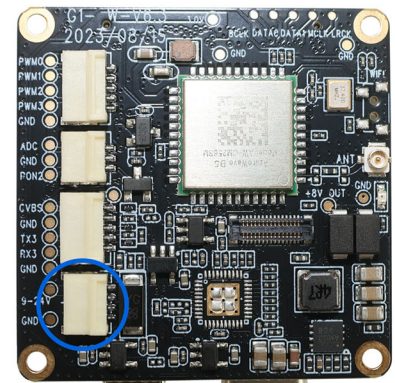
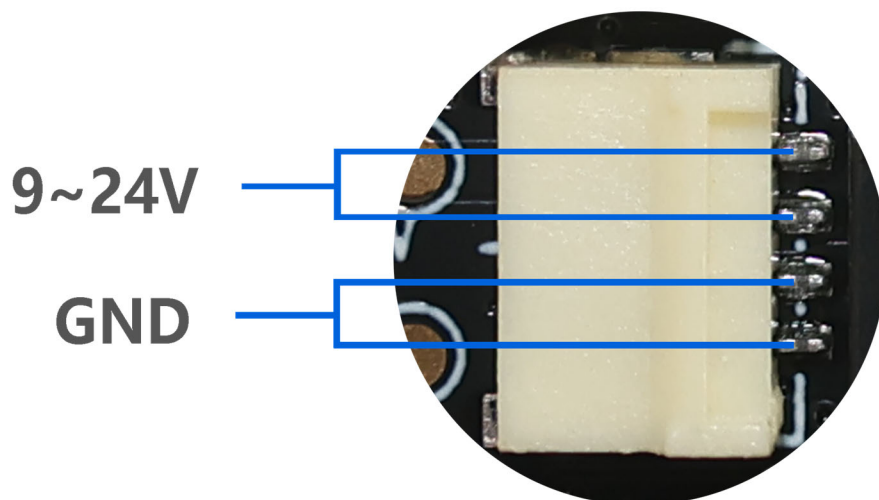



KLT-G1WF V6.3 WiFi Expansion Board

Special note:

The three-axis gimbal does not support 5V USB power supply alone. The battery power supply can support up to 12V; but this does not include the gimbal version, the stable power supply voltage of the battery for gimbal version is 8V.

wifi板连接主板扩展板接口

wifi board connect to main board

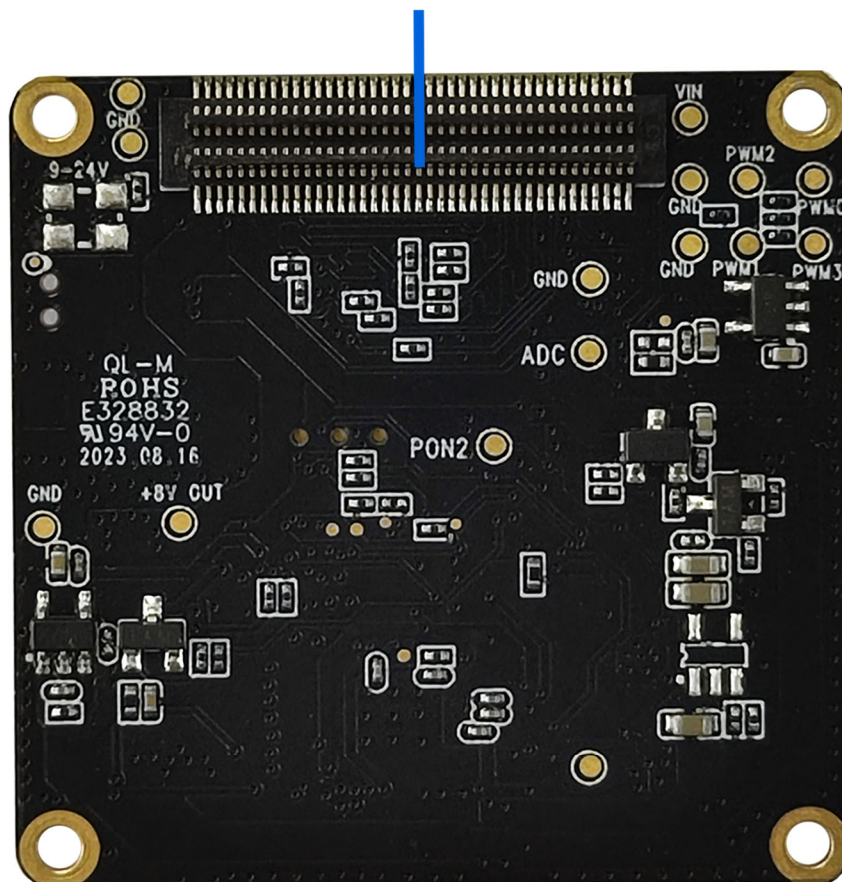

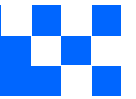

KLT-CMFL60101-IMX335 V1.0

5.14MP Sony IMX335 Fixed Focus Camera Module

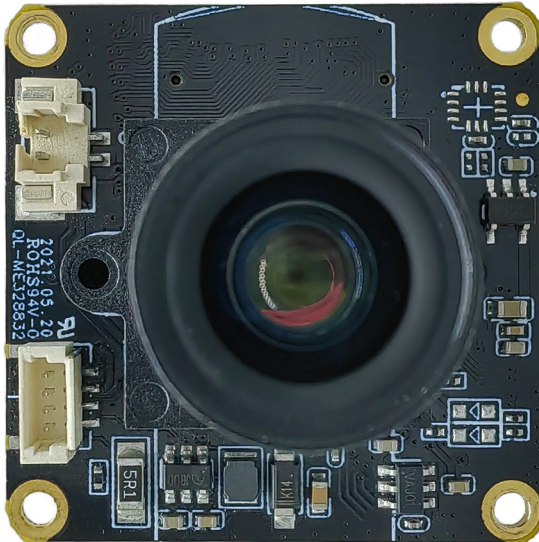

Front View

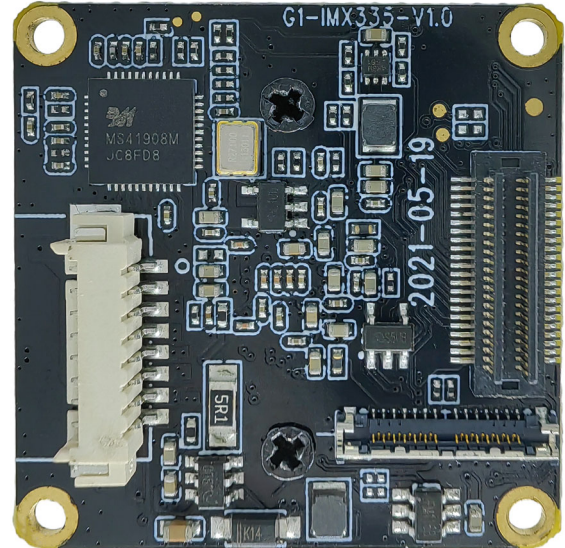

Back View

Overview

The KLT-CMFL60101-IMX335 V1.0 camera module uses the Sony IMX335 high-quality CMOS image sensor, which has a diagonal of 6.52mm (1/2.8 type) CMOS image sensor, a pixel of 2.0um, a color square pixel display, and an effective pixel of 5.14 megapixels.

When used with the master board, it can support shooting 5MP pixel high-definition photos and up to 2.7K@30FPS video. The board frame size is 32x32mm, and the size from the top of the module lens to the PCB board is 32x32x23.5mm.

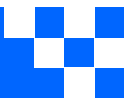

KLT-CMFL60101-IMX335 V1.0

5.14MP Sony IMX335 Fixed Focus Camera Module

Specifications

Model No.	KLT-CMFL60101-IMX335 V1.0
Image Sensor	IMX335
Image Sensor Type	CMOS
Effective Pixels	5.14 Megapixels
Sensor Size	1/2.8"
Pixel Size	2.0 um x 2.0 um
Video Frame Rate	4K@30FPS/60FPS (Differential) 2.7K@30FPS 1080P@30FPS/60FPS 720P@60FPS/120FPS
Photo Resolution (with Master Board)	20MP (5200x3900) (Differential) 13MP (4160x3120) (Differential) 12MP (4000x3000) (Differential) 10MP (3648x2736) (Differential) 8MP (3264x2448) (Differential) 5MP (2592x1944) Default 3MP (2048x1536) 2MP (1920x1080)
Operating Temperature	-10°C to +60°C
Storage Temperature	-20°C to +80°C
Humidity	20% to 80%
PCB Dimensions	32 x 32 mm
Module Size	32 x 32 x 23.5 mm
PCB Screw Hole Spacing	28 x 28 mm
PCB Screw Hole Diameter	2 mm

KLT-CMFL60101-IMX335 V1.0

5.14MP Sony IMX335 Fixed Focus Camera Module

Lens Specifications

Lens Model No.	HX60101
EFL (Focal Length)	7 mm
TTL (Total Length)	22.27 mm
F. No.	1.65
Lens Barrel Thread	M12 x P0.5
Lens Construction	6E
Diagonal View Angle (DFOV)	52.2° (DFOV)
Horizontal View Angle (HFOV)	45.8° (HFOV)
Vertical View Angle (VFOV)	26.2° (VFOV)
Chief-Ray Angle	10.7°
Distortion	-3.60%
Relative Illumination	>57.1%
Lens Operating Temperature	-20°C to +60°C
Lens Storage Temperature	-30°C to +80°C

Lens Drawing

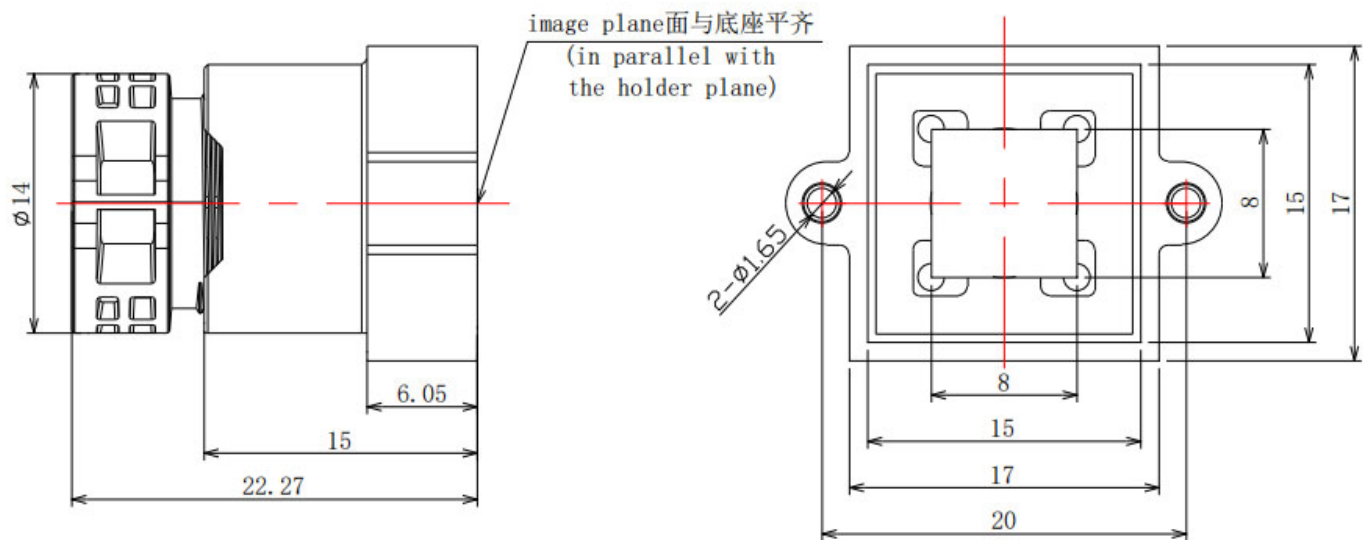

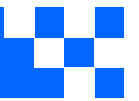
**KLT-CMFL60101-IMX335 V1.0****5.14MP Sony IMX335 Fixed Focus Camera Module**

通过板对板连接器支持自动AF变焦镜头 Sensor、IR-CUT、LED等

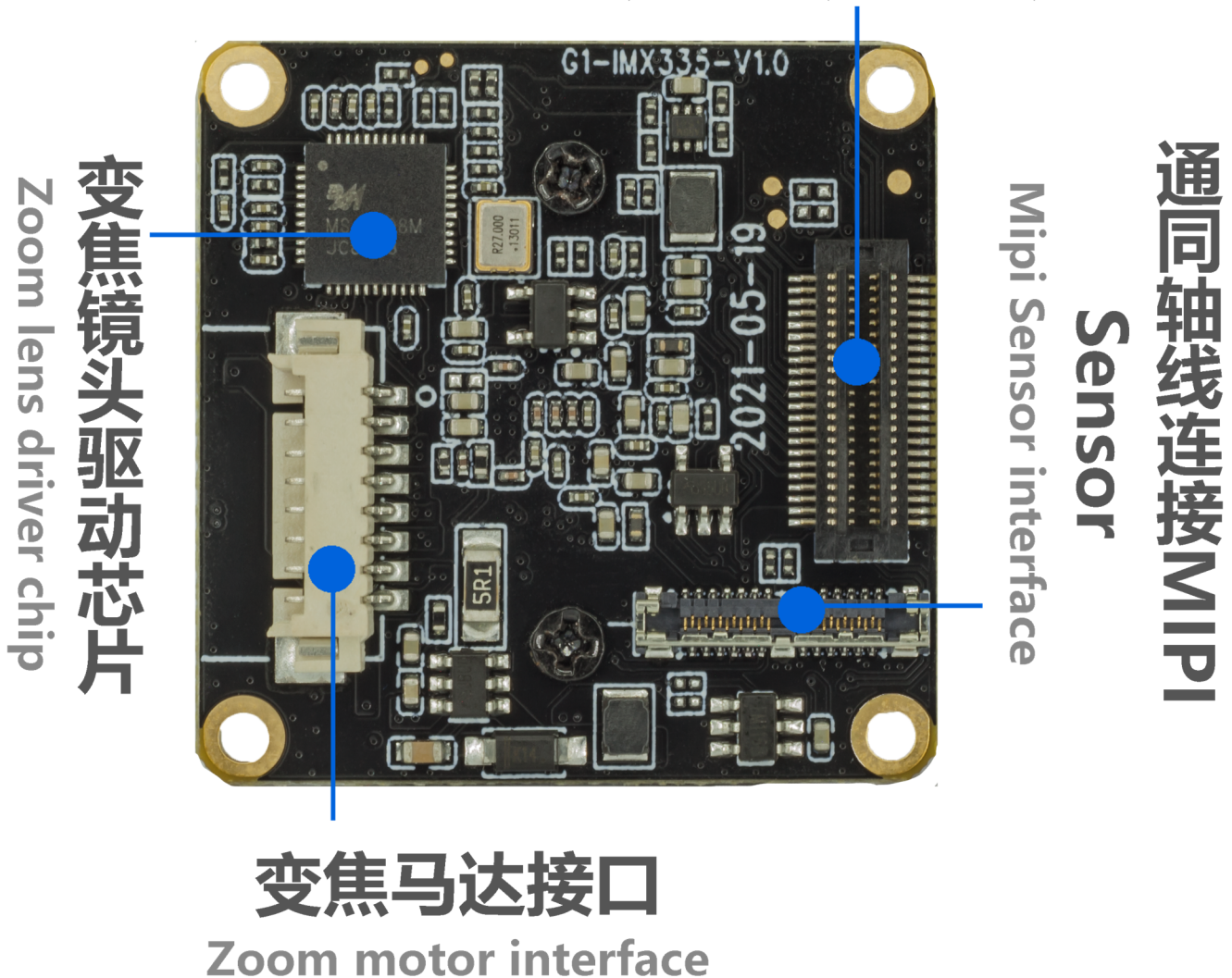
Connect AF Zoom Lens、Sensor、IR-CUT、Led

KLT-CMFL60101-IMX335 V1.0

5.14MP Sony IMX335 Fixed Focus Camera Module

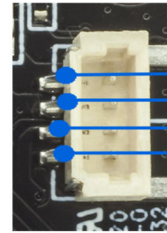
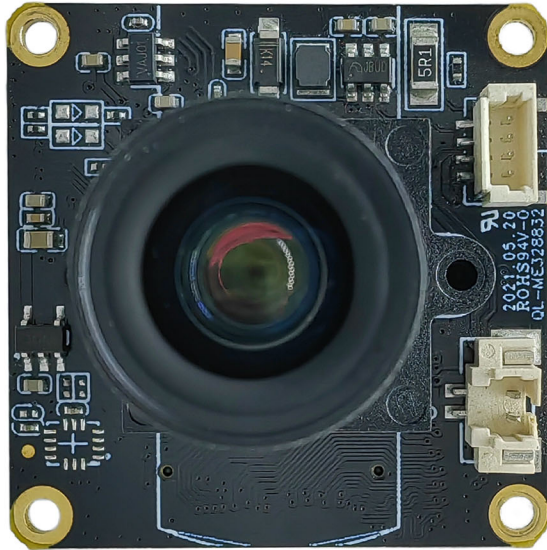

LED B -
LED B +
LED A -
LED A +

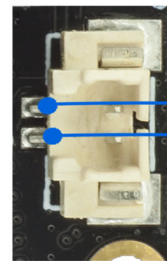

IR-CUT -
IR-CUT +

The two groups of fill light interfaces support the expansion of infrared lights and white light boards to provide fill light for the device. Note: The IR-Cut filter switch interface is used by lenses with filters, but this camera module does not support this function.

ZOOM A -
ZOOM A +
FOCUS A -
FOCUS A +
FOCUS B +
FOCUS B -
ZOOM B -
ZOOM B +

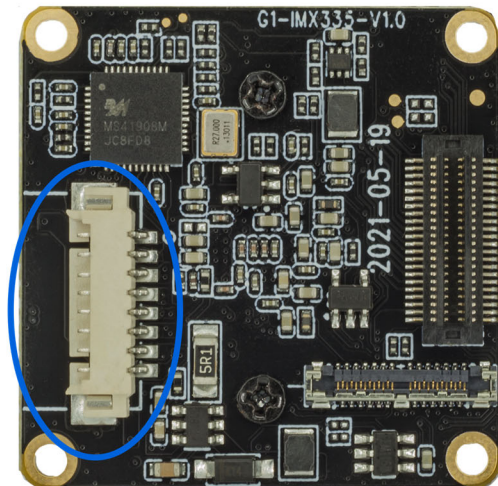
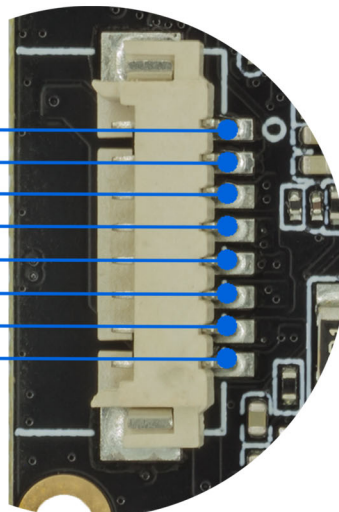

The auto focus interface leads to the connection automatically focusing motor to achieve the zoom function, but this camera module does not support zoom function.

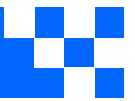

KLT-CMFL60101-IMX335 V1.0
5.14MP Sony IMX335 Fixed Focus Camera Module

滤光片切换器接口
IR-CUT INTERFACE

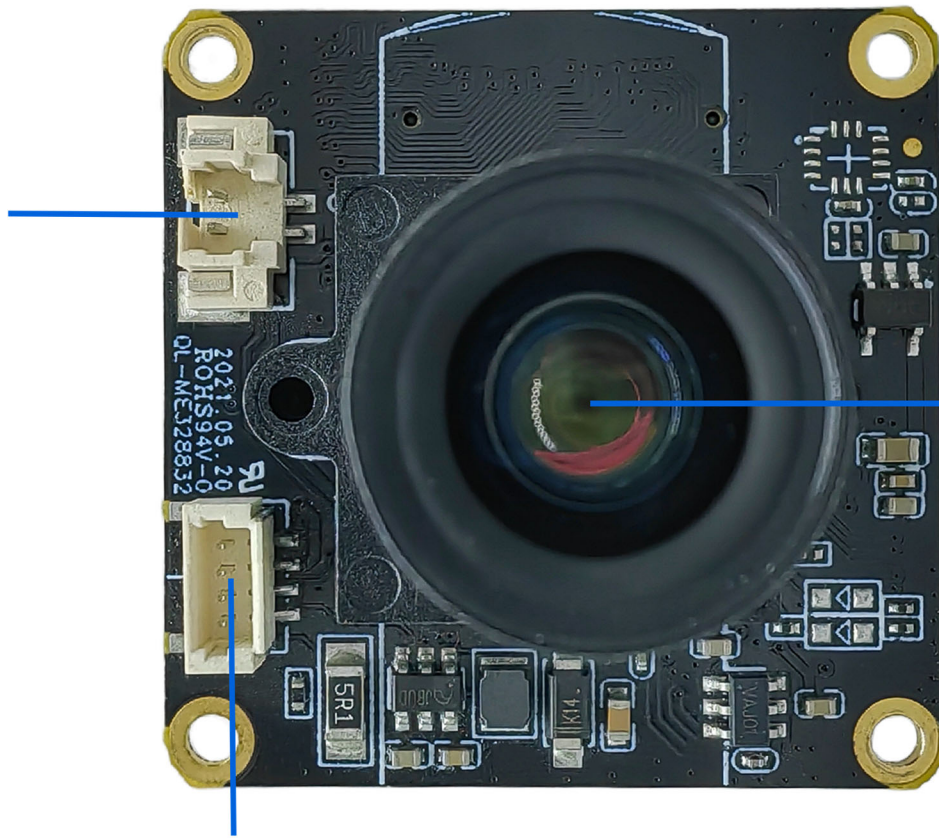

G1 IMX335 HX60101
V1.0 镜头模组

两组LED补光灯接口
LEDS * 2 INTERFACE

Note: You can choose between TBT board-to-board socket or connecting to the master board via coaxial cable. Users can use them flexibly according to the construction scenarios.

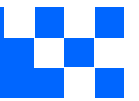

KLT-CMFL60101-IMX335 V1.0
5.14MP Sony IMX335 Fixed Focus Camera Module

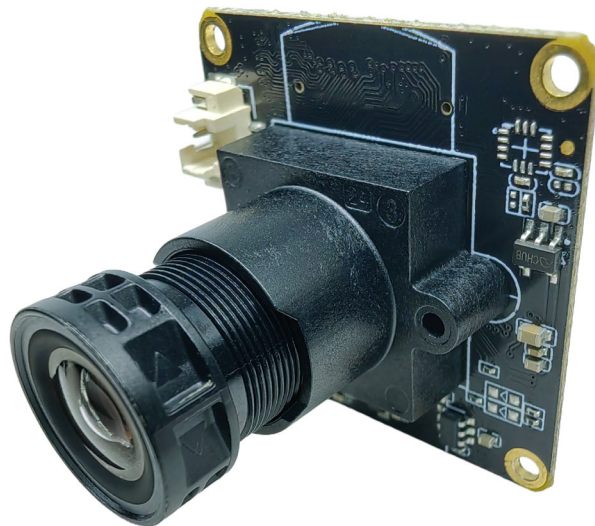
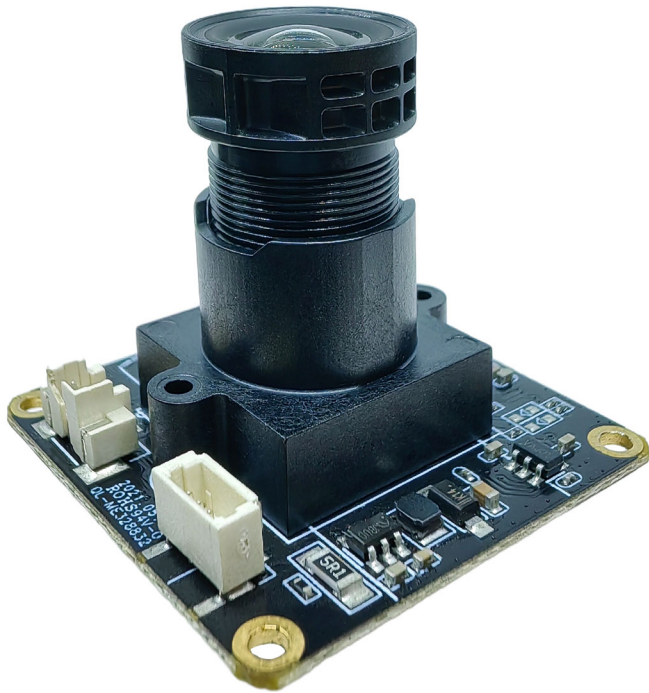

[Product Information]

Ver.1.0

IMX335LLN

Diagonal 6.52 mm (Type 1 / 2.8) CMOS Solid-state Image Sensor with Square Pixel for Monochrome Cameras

Description

The IMX335LLN is a diagonal 6.52 mm (Type 1 / 2.8) CMOS active pixel type solid-state image sensor with a square pixel array and 5.14 M effective pixels. This chip operates with analog 2.9 V, digital 1.2 V, and interface 1.8 V triple power supply, and has low power consumption. High sensitivity, low dark current and no smear are achieved. This chip features an electronic shutter with variable charge-integration time.

(Applications: Surveillance cameras, FA cameras, Industrial cameras)

Features

- ◆ CMOS active pixel type dots
- ◆ Built-in timing adjustment circuit, H/V driver and serial communication circuit
- ◆ Input frequency: 6 to 27 MHz / 37.125 MHz / 74.25 MHz
- ◆ Number of recommended recording pixels: 2592 (H) × 1944 (V) approx. 5.04 M pixels
- ◆ Readout mode
 - All-pixel scan mode
 - Window cropping mode
 - Vertical / Horizontal direction-normal / inverted readout mode
- ◆ Readout rate
 - Maximum frame rate in All-pixel scan mode 2592(H) × 1944(V) A/D 10-bit : 60 frame/s
- ◆ High dynamic range (HDR) function
 - Multiple exposure HDR
 - Digital overlap HDR
- ◆ Variable-speed shutter function (resolution 1H units)
- ◆ 10-bit / 12-bit A/D converter
- ◆ CDS / PGA function
 - 0 dB to 30 dB : Analog Gain 30 dB (step pitch 0.3 dB)
 - 30.3 dB to 72 dB : Analog Gain 30 dB + Digital Gain 0.3 to 42 dB (step pitch 0.3 dB)
- ◆ Supports I/O
 - CSI-2 serial data output (2 Lane / 4 Lane, RAW10 / RAW12 output)
- ◆ Recommended exit pupil distance: -100 mm to $-\infty$

STARVIS

* STARVIS is a trademark of Sony Corporation. The STARVIS is back-illuminated pixel technology used in CMOS image sensors for surveillance camera applications. It features a sensitivity of 2000 mV or more per $1 \mu\text{m}^2$ (color product, when imaging with a 706 cd/m² light source, F5.6 in 1 s accumulation equivalent), and realizes high picture quality in the visible-light and near infrared light regions.

Sony reserves the right to change products and specifications without prior notice.

Sony logo is a registered trademark of Sony Corporation.

Device Structure

- ◆ CMOS image sensor
- ◆ Image size Type 1/2.8
- ◆ Total number of pixels 2704 (H) × 2104 (V) approx. 5.69 M pixels
- ◆ Number of effective pixels 2616 (H) × 1964 (V) approx. 5.14 M pixels
- ◆ Number of active pixels 2616 (H) × 1960 (V) approx. 5.13 M pixels
- ◆ Number of recommended recording pixels 2592 (H) × 1944 (V) approx. 5.04 M pixels
- ◆ Unit cell size 2.0 μm (H) × 2.0 μm (V)
- ◆ Optical black Horizontal (H) direction: Front 0 pixel, rear 0 pixel
Vertical (V) direction: Front 13 pixels, rear 0 pixel
- ◆ Dummy Horizontal (H) direction: Front 0 pixel, rear 0 pixel
Vertical (V) direction: Front 0 pixel, rear 0 pixel
- ◆ Package 88 pin BGA

Image Sensor Characteristics

(Tj = 60 °C)

Item		Value	Remarks
Sensitivity (F8)	Typ.	1961 Digit	1/30 s accumulation 12 bit converted value
Saturation signal	Min.	3895 Digit	12 bit converted value

Basic Drive Mode

Drive mode	Recommended number of recording pixels	Maximum frame rate [frame/s]	Output interface	ADC [bit]
All pixel	2592 (H) × 1944 (V) approx. 5.04 M pixels	60	CSI-2	10

[Product Information]

IMX335LQN

Ver.1.1

Diagonal 6.52 mm (Type 1/2.8) CMOS Solid-state Image Sensor with Square Pixel for Color Cameras

Description

The IMX335LQN is a diagonal 6.52 mm (Type 1/2.8) CMOS active pixel type solid-state image sensor with a square pixel array and 5.14 M effective pixels. This chip operates with analog 2.9 V, digital 1.2 V, and interface 1.8 V triple power supply, and has low power consumption. High sensitivity, low dark current and no smear are achieved through the adoption of R, G and B primary color mosaic filters. This chip features an electronic shutter with variable charge-integration time.

(Applications: Surveillance cameras, FA cameras, Industrial cameras)

Features

- ◆ CMOS active pixel type dots
- ◆ Built-in timing adjustment circuit, H/V driver and serial communication circuit
- ◆ Input frequency: 6 to 27 MHz / 37.125 MHz / 74.25 MHz
- ◆ Number of recommended recording pixels: 2592 (H) × 1944 (V) approx. 5.04 M pixels
- ◆ Readout mode
 - All-pixel scan mode
 - Horizontal/Vertical 2/2-line binning mode
 - Window cropping mode
 - Vertical / Horizontal direction-normal / inverted readout mode
- ◆ Readout rate
 - Maximum frame rate in All-pixel scan mode 2592 (H) × 1944 (V) A/D 10-bit : 60 frame/s
- ◆ High dynamic range (HDR) function
 - Multiple exposure HDR
 - Digital overlap HDR
- ◆ Variable-speed shutter function (resolution 1H units)
- ◆ 10-bit / 12-bit A/D converter
- ◆ CDS / PGA function
 - 0 dB to 30 dB : Analog Gain 30 dB (step pitch 0.3 dB)
 - 30.3 dB to 72 dB : Analog Gain 30 dB + Digital Gain 0.3 to 42 dB (step pitch 0.3 dB)
- ◆ Supports I/O
 - CSI-2 serial data output (2 Lane / 4 Lane, RAW10 / RAW12 output)
- ◆ Recommended exit pupil distance: -30 mm to $-\infty$

STARVIS

* STARVIS is a trademark of Sony Corporation. The STARVIS is back-illuminated pixel technology used in CMOS image sensors for surveillance camera applications. It features a sensitivity of 2000 mV or more per $1 \mu\text{m}^2$ (color product, when imaging with a 706 cd/m^2 light source, F5.6 in 1 s accumulation equivalent), and realizes high picture quality in the visible-light and near infrared light regions.

Sony reserves the right to change products and specifications without prior notice.

Sony logo is a registered trademark of Sony Corporation.

Device Structure

- ◆ CMOS image sensor
- ◆ Image size Type 1/2.8
- ◆ Total number of pixels 2704 (H) × 2104 (V) approx. 5.69 M pixels
- ◆ Number of effective pixels 2616 (H) × 1964 (V) approx. 5.14 M pixels
- ◆ Number of active pixels 2616 (H) × 1960 (V) approx. 5.11 M pixels
- ◆ Number of recommended recording pixels 2592 (H) × 1944 (V) approx. 5.04 M pixels
- ◆ Unit cell size 2.0 μm (H) × 2.0 μm (V)
- ◆ Optical black Horizontal (H) direction: Front 0 pixel, rear 0 pixel
Vertical (V) direction: Front 13 pixels, rear 0 pixel
- ◆ Dummy Horizontal (H) direction: Front 0 pixel, rear 0 pixel
Vertical (V) direction: Front 0 pixel, rear 0 pixel
- ◆ Package 88 pin CSP BGA

Image Sensor Characteristics

(T_j = 60 °C)

Item		Value	Remarks
Sensitivity (F5.6)	Typ.	2200 Digit	1/30 s accumulation 12 bit converted value
Saturation signal	Min.	3895 Digit	12 bit converted value

Basic Drive Mode

Drive mode	Recommended number of recording pixels	Maximum frame rate [frame/s]	Output interface	ADC [bit]
All pixel	2592 (H) × 1944 (V) approx. 5.04 M pixels	60	CSI-2	10
Horizontal/ Vertical 2/2-line binning	1296 (H) × 972 (V) approx. 1.26 M pixels	60	CSI-2	10

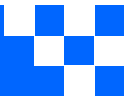

Cameras Applications



Automotive Driver Pilot



Live Streaming



Video Conference



Eye Tracker Biometric Detection

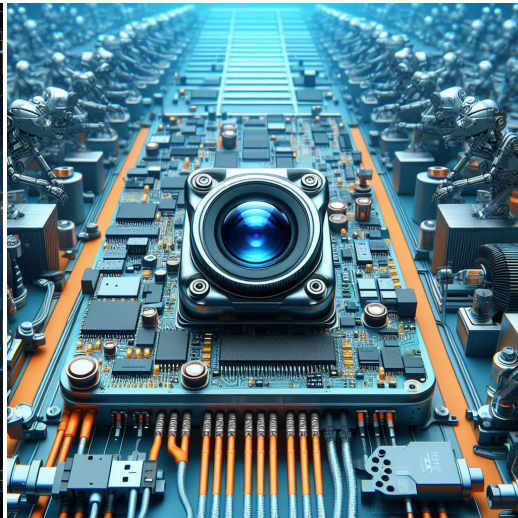

Machine Vision



Agricultural Monitor

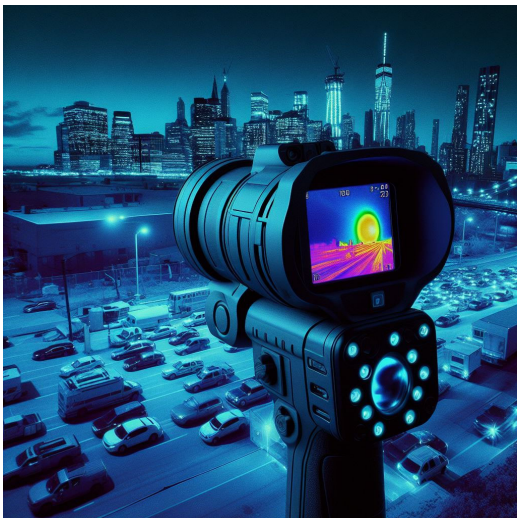

Night Vision Security



Drone and Sports Eagle Eyes



Interactive Pet Camera

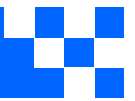

your **BEST** camera module partner

Cameras Applications



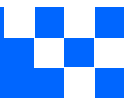

Camera Module Pinout Definition Reference Chart

OmniVision	Sony	Samsung	On-Semi	Aptina	Himax	GalaxyCore	PixArt	SmartSens	Sensors	
Pin Signal										
Description										
DGND GND										ground for digital circuit
AGND										ground for analog circuit
PCLK DCK										DVP PCLK output
XCLR PWDN XSHUTDOWN STANDBY										power down active high with internal pull-down resistor
MCLK XVCLK XCLK INCK										system input clock
RESET RST										reset active low with internal pull-up resistor
NC NULL										no connect
SDA SIO_D SIOD										SCCB data
SCL SIO_C SIOC										SCCB input clock
VSYNC XVS FSYNC										DVP VSYNC output
HREF XHS										DVP HREF output
DOVDD										power for I/O circuit
AFVDD										power for VCM circuit
AVDD										power for analog circuit
DVDD										power for digital circuit
STROBE FSTROBE										strobe output
FSIN										synchronize the VSYNC signal from the other sensor
SID										SCCB last bit ID input
ILPWM										mechanical shutter output indicator
FREQ										frame exposure / mechanical shutter
GPIO										general purpose inputs
SLASEL										I2C slave address select
AFEN										CEN chip enable active high on VCM driver IC
MIPI Interface										
MDN0 DN0 MD0N DATA_N DMO1N										MIPI 1st data lane negative output
MDP0 DP0 MD0P DATA_P DMO1P										MIPI 1st data lane positive output
MDN1 DN1 MD1N DATA2_N DMO2N										MIPI 2nd data lane negative output
MDP1 DP1 MD1P DATA2_P DMO2P										MIPI 2nd data lane positive output
MDN2 DN2 MD2N DATA3_N DMO3N										MIPI 3rd data lane negative output
MDP2 DP2 MD2P DATA3_P DMO3P										MIPI 3rd data lane positive output
MDN3 DN3 MD3N DATA4_N DMO4N										MIPI 4th data lane negative output
MDP3 DP3 MD3P DATA4_P DMO4P										MIPI 4th data lane positive output
MCN CLKN CLK_N DCKN										MIPI clock negative output
MCP CLKP MCP CLK_P DCKN										MIPI clock positive output
DVP Parallel Interface										
D0 DO0 Y0										DVP data output port 0
D1 DO1 Y1										DVP data output port 1
D2 DO2 Y2										DVP data output port 2
D3 DO3 Y3										DVP data output port 3
D4 DO4 Y4										DVP data output port 4
D5 DO5 Y5										DVP data output port 5
D6 DO6 Y6										DVP data output port 6
D7 DO7 Y7										DVP data output port 7
D8 DO8 Y8										DVP data output port 8
D9 DO9 Y9										DVP data output port 9
D10 DO10 Y10										DVP data output port 10
D11 DO11 Y11										DVP data output port 11



Camera Reliability Test

Reliability Inspection Item		Testing Method	Acceptance Criteria	
Category	Item			
Environmental	Storage Temperature	High 60°C 96 Hours	Temperature Chamber	No Abnormal Situation
		Low -20°C 96 Hours	Temperature Chamber	No Abnormal Situation
	Operation Temperature	High 60°C 24 Hours	Temperature Chamber	No Abnormal Situation
		Low -20°C 24 Hours	Temperature Chamber	No Abnormal Situation
	Humidity	60°C 80% 24 Hours	Temperature Chamber	No Abnormal Situation
	Thermal Shock	High 60°C 0.5 Hours Low -20°C 0.5 Hours Cycling in 24 Hours	Temperature Chamber	No Abnormal Situation
Physical	Drop Test (Free Falling)	Without Package 60cm	10 Times on Wood Floor	Electrically Functional
		With Package 60cm	10 Times on Wood Floor	Electrically Functional
	Vibration Test	50Hz X-Axis 2mm 30min	Vibration Table	Electrically Functional
		50Hz Y-Axis 2mm 30min	Vibration Table	Electrically Functional
		50Hz Z-Axis 2mm 30min	Vibration Table	Electrically Functional
	Cable Tensile Strength Test	Loading Weight 4 kg 60 Seconds Cycling in 24 Hours	Tensile Testing Machine	Electrically Functional
Electrical	ESD Test	Contact Discharge 2 KV	ESD Testing Machine	Electrically Functional
		Air Discharge 4 KV	ESD Testing Machine	Electrically Functional
	Aging Test	On/Off 30 Seconds Cycling in 24 Hours	Power Switch	Electrically Functional
	USB Connector	On/Off 250 Times	Plug and Unplug	Electrically Functional





Inspection Item		Inspection Method	Standard of Inspection		
Category	Item				
Appearance	FPC/ PCB	Color	The Naked Eye	Major Difference is Not Allowed.	
		Be Torn/Chopped	The Naked Eye	Copper Crack Exposure is Not Allowed.	
		Marking	The Naked Eye	Clear, Recognizable (Within 30cm Distance)	
	Holder	Scratches	The Naked Eye	The Inside Crack Exposure is Not Allowed	
		Gap	The Naked Eye	Meet the Height Standard	
		Screw	The Naked Eye	Make Sure Screws Are Presented (If Any)	
		Damage	The Naked Eye	The Inside Crack Exposure is Not Allowed	
	Lens	Scratch	The Naked Eye	No Effect On Resolution Standard	
		Contamination	The Naked Eye	No Effect On Resolution Standard	
		Oil Film	The Naked Eye	No Effect On Resolution Standard	
		Cover Tape	The Naked Eye	No Issue On Appearance.	
	Function	Image	No Communication	Test Board	Not Allowed
			Bright Pixel	Black Board	Not Allowed In the Image Center
Dark Pixel			White board	Not Allowed In the Image Center	
Blurry			The Naked Eye	Not Allowed	
No Image			The Naked Eye	Not Allowed	
Vertical Line			The Naked Eye	Not Allowed	
Horizontal Line			The Naked Eye	Not Allowed	
Light Leakage			The Naked Eye	Not Allowed	
Blinking Image			The Naked Eye	Not Allowed	
Bruise			Inspection Jig	Not Allowed	
Resolution			Chart	Follows Outgoing Inspection Chart Standard	
Color			The Naked Eye	No Issue	
Noise			The Naked Eye	Not Allowed	
Corner Dark			The Naked Eye	Less Than 100px By 100px	
Color Resolution			The Naked Eye	No Issue	
Dimension	Height	The Naked Eye	Follows Approval Data Sheet		
	Width	The Naked Eye	Follows Approval Data Sheet		
	Length	The Naked Eye	Follows Approval Data Sheet		
	Overall	The Naked Eye	Follows Approval Data Sheet		



KLT Package Solutions

KLT Camera Module

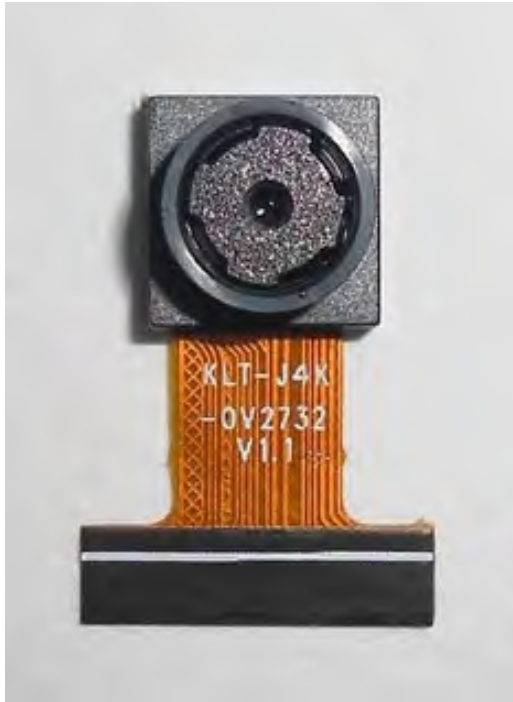

Complete with Lens Protection Film



Tray with Grid and Space



Place Cameras on the Tray

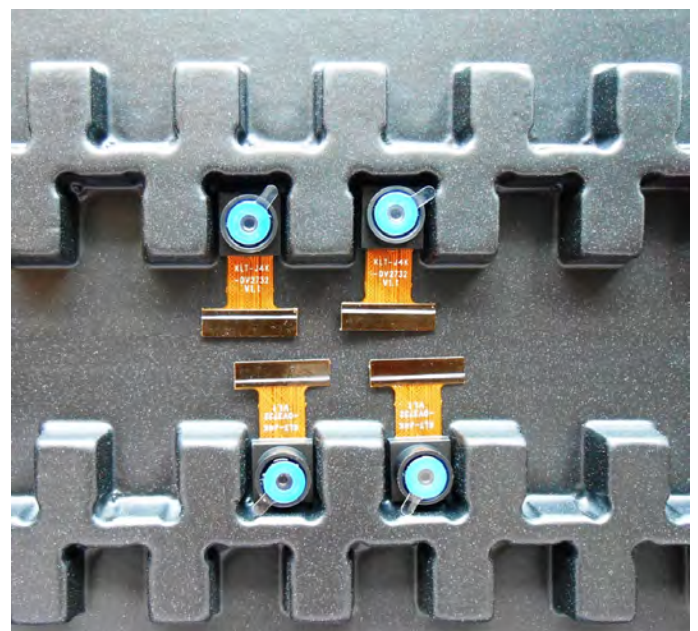



Camera Modules Package Solution

Full Tray of Cameras



Cover Tray with Lid

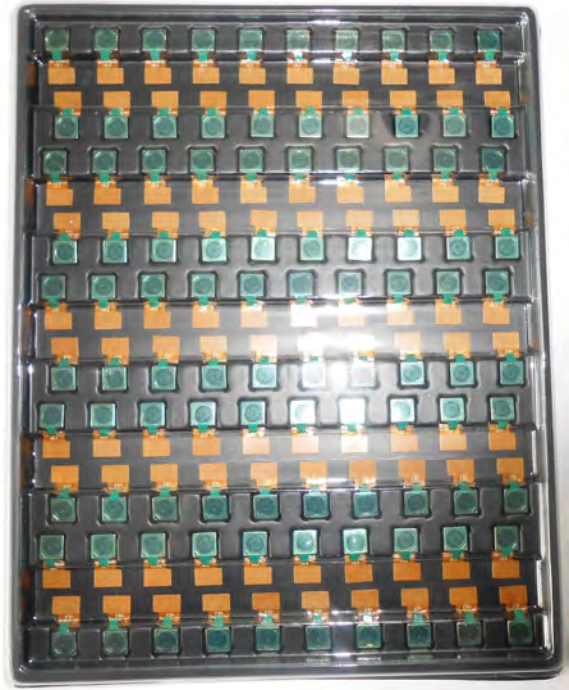

Put Tray into Anti-Static Bag



Vacuum the Anti-Static Bag

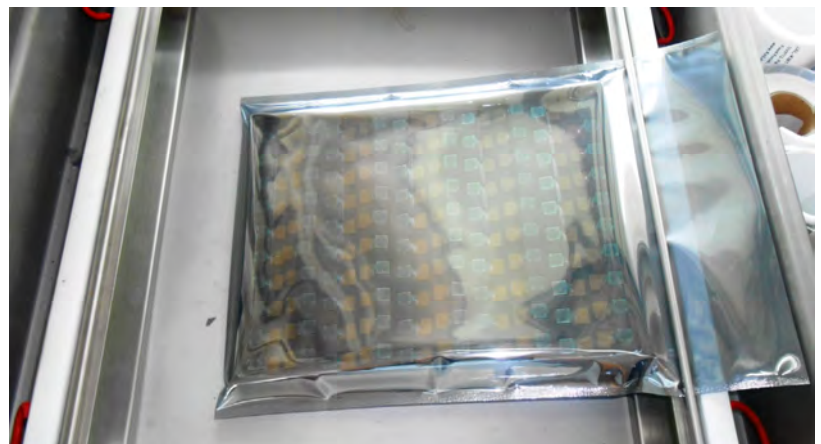



Camera Modules Package Solution

Sealed Vacuum Bag with Labels

1. Model and Description 2. Quantity 3. Shipping Date 4. Caution





Large Order Package Solution

Place Foam Sheets Between Trays



Foam Sheets are Slightly Larger than Trays



Place Foam Sheets and Trays into Box



Foam Sheets are Tightly Fitting Box





Small Order Package Solution

Place Foam Sheets and Trays into Small Box



Foam Sheets are Nicely Fitting the Small Box



Package in Small Box for Shipment



Place Small Boxes into Larger Box





your BEST camera module partner

Carbon Box Package Solution

Seal the Carbon Box

Final Package Labelled Box



Carbon Box Ready for Shipment

1. Delivery Address and Phone No. 2. Box No. and Ship Date 3. Fragile Caution





Sample Order Package Solution

Place Sample into Small Anti-Static Bag



Place Connectors into Small Ant-Static Bag



Sample Labels on the Small Bag

1. Camera Module or Connector Model
2. Shipping Date and Quantity
3. Caution





your BEST camera module partner

Connectors Large Order Package Solution

Connectors in a Wheel



Label Connectors in the Wheel



The Wheel is Perfectly Fitting the Box



Connectors Box Ready for Shipment





your BEST camera module partner

Company Kai Lap Technologies (KLT)

Kai Lap Technologies Group Limited. (KLT) was established in 2009, a next-generation technology driven manufacturer specialized in research, design, and produce of audio and video products. KLT is occupying 20,000 square feet automated plants with 100 employees of annual throughput 30,000,000 units cameras.

KLT provides OEM, ODM design, contract manufacturing, and builds the camera products. You may provide the requirements to us, even with a hand draft, our sales and engineering work together to meet your needs. We consider ourselves your last-term partner in developing practical and innovative solutions.

Our team covers everything from initial concept development to mass produced product. KLT specializes in customized camera design, raw material, electronic engineering, firmware/software development, product testing, and packing design. Our experienced strategic supply systems offer a robust and dependable manufacturing capacity for orders of various sizes.

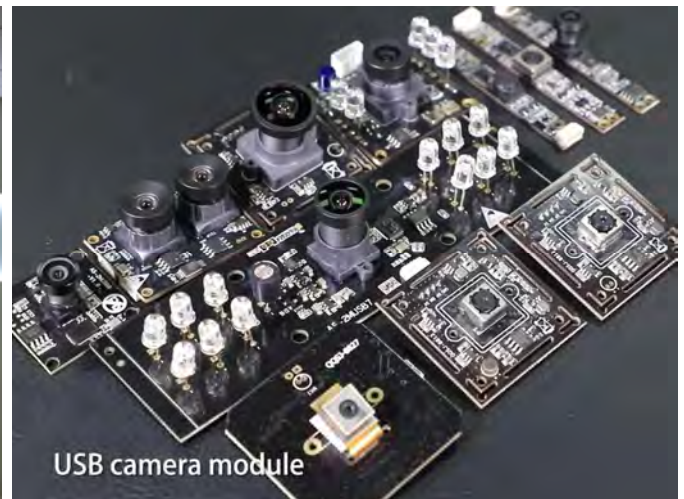

Limited Warranty

KLT provides the following limited warranty if you purchased the Product(s) directly from KLT company or from KLT's website, www.KaiLapTech.com. Product(s) purchased from other sellers or sources are not covered by this Limited Warranty. KLT guarantees that the Product(s) will be free from defects in materials and workmanship under normal use for a period of one (1) year from the date you receive the product ("Warranty Period").

For all Product(s) that contain or develop material defects in materials or workmanship during the Warranty Period, KLT will, at its sole option, either: (i) repair the Product(s); (ii) replace the Product(s) with a new or refurbished Product(s) (replacement Product(s) being of identical model or functional equivalent); or (iii) provide you a refund of the price you paid for the Product(s).

This Limited Warranty of KLT is solely limited to repair and/or replacement on the terms set forth above. KLT is not reliable or responsible for any subsequent events.





CMOS CAMERA MODULES

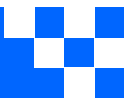

your BEST camera module partner

KLT Strength

Powerful Factory



Professional Service



Promised Delivery



www.KaiLapTech.com sales@KaiLapTech.com Tel: (852) 6908 1256 Fax: (852) 3017 6778

All rights reserved @ Kai Lap Technologies Group Ltd. Specifications subject to change without notice.